

RC bridge balustrade replacements

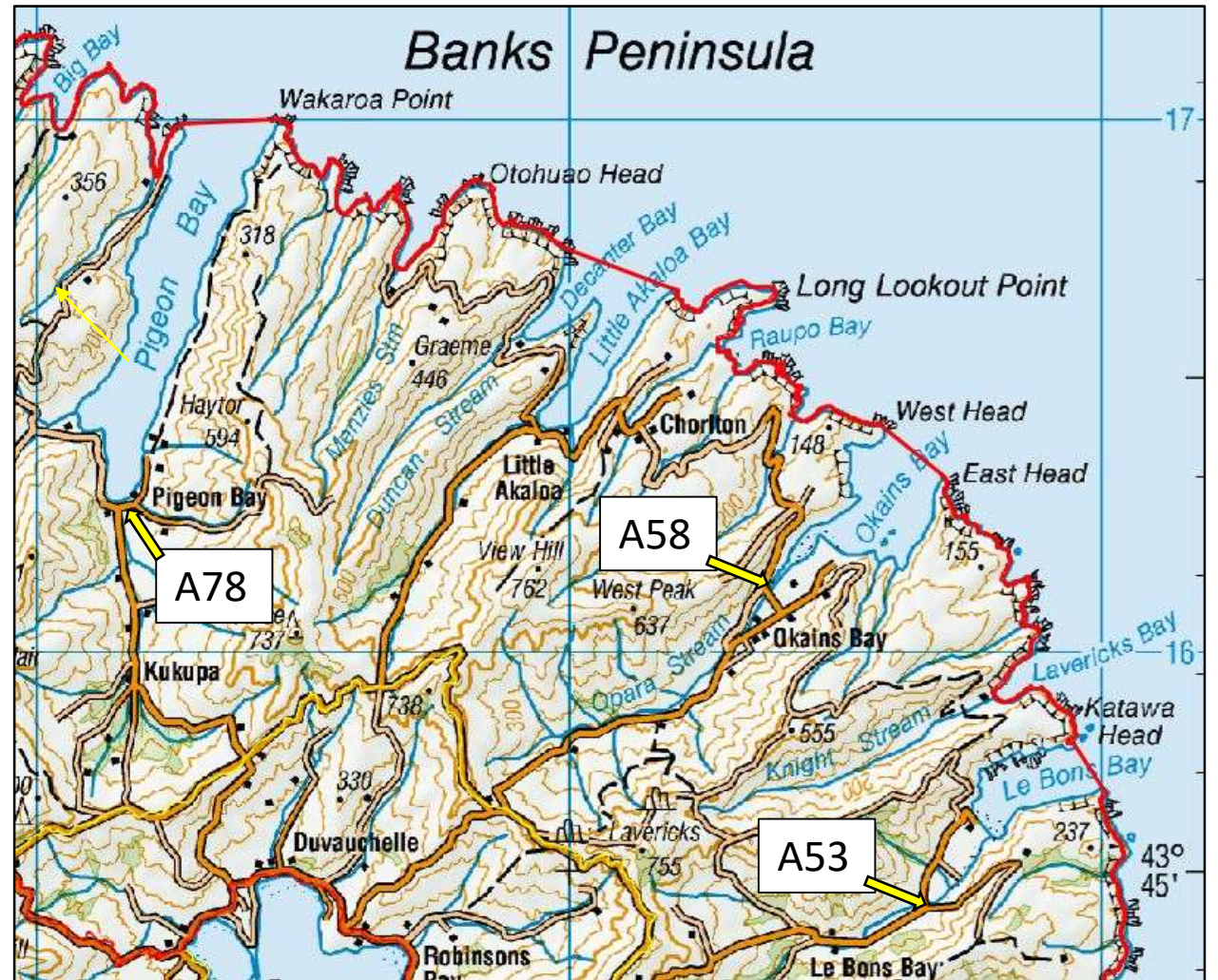



Bridge Locations



Superstructure of bridges are in good condition



Typical damage/spalling issues



Typical balustrade structure

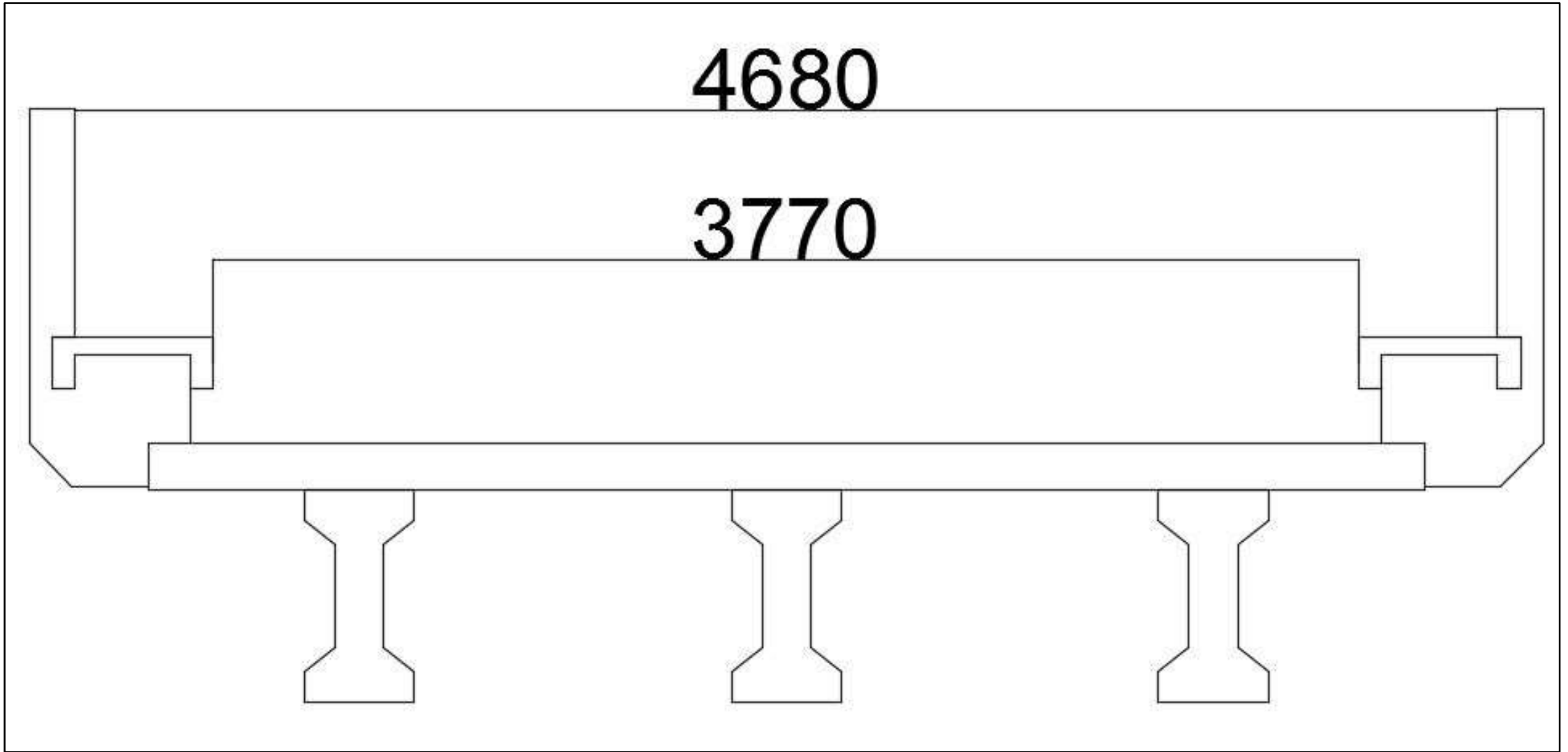

Existing structure

3388

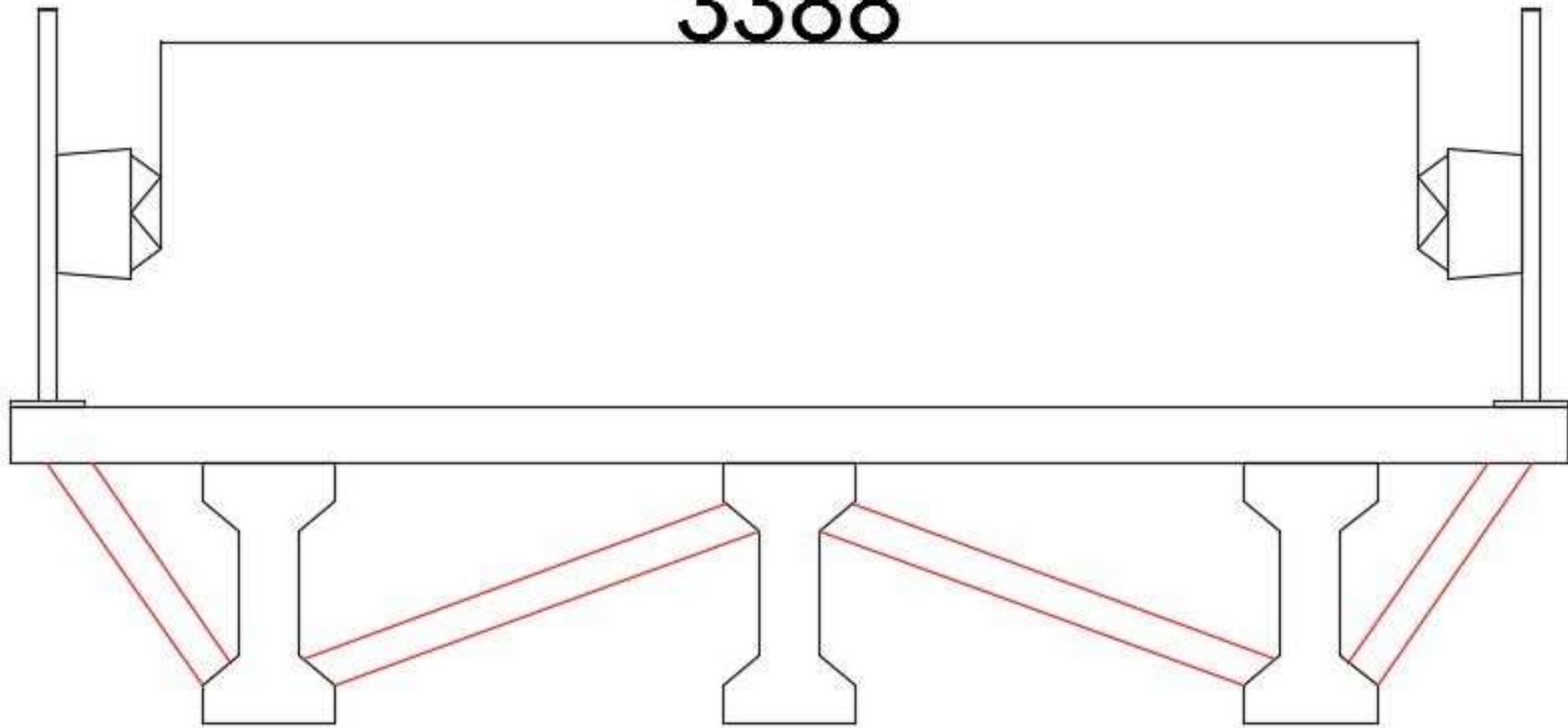

Initial Solution

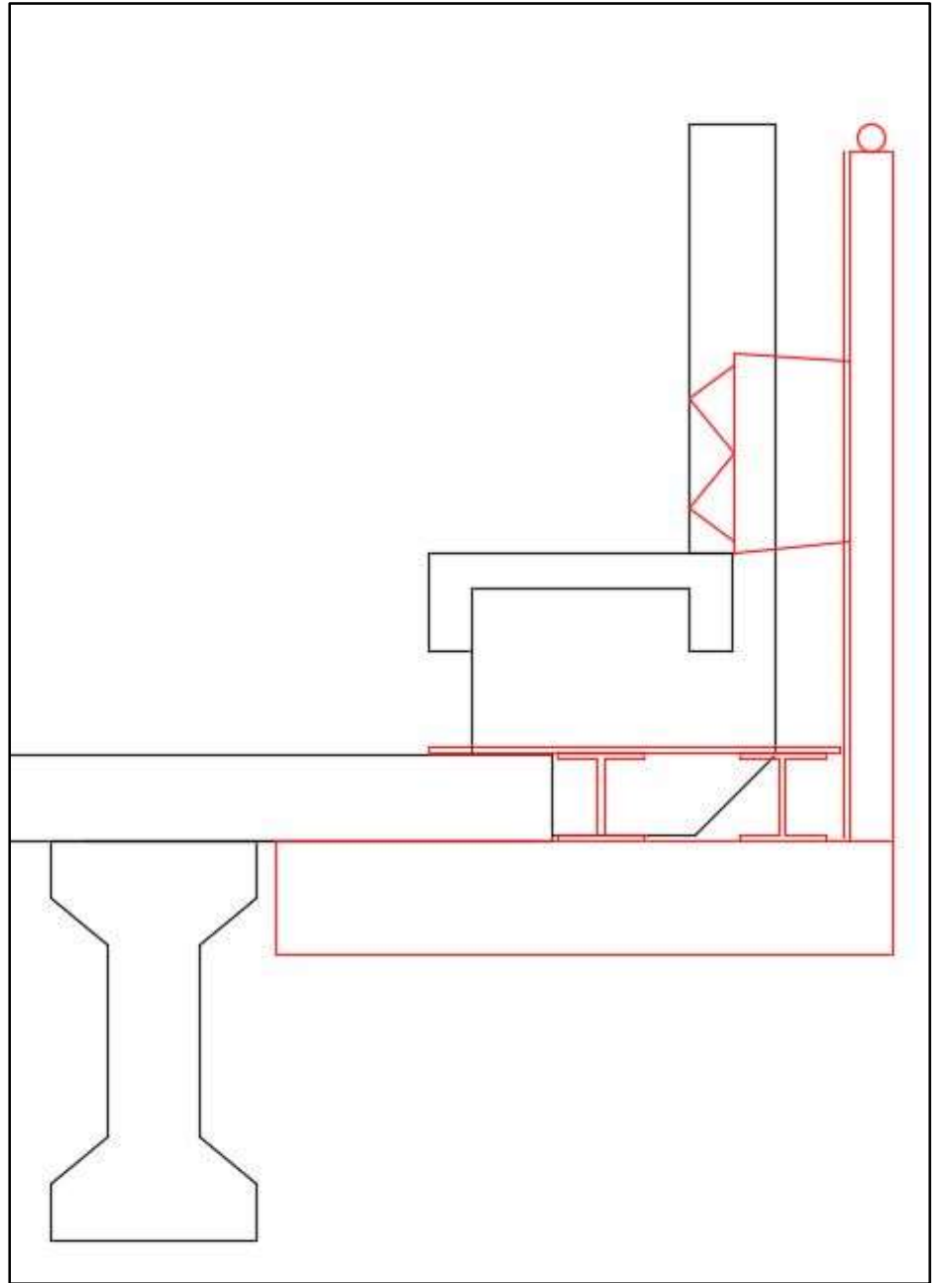
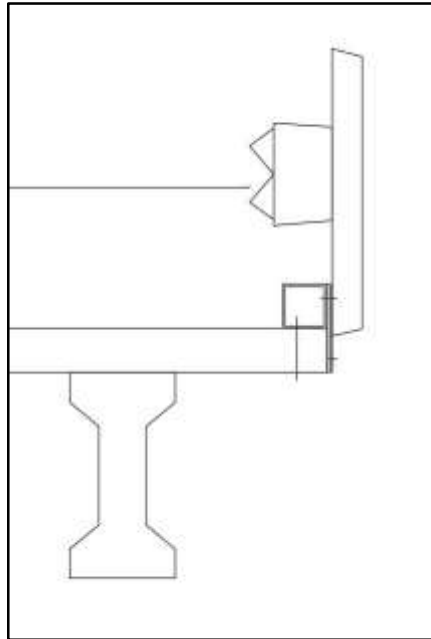
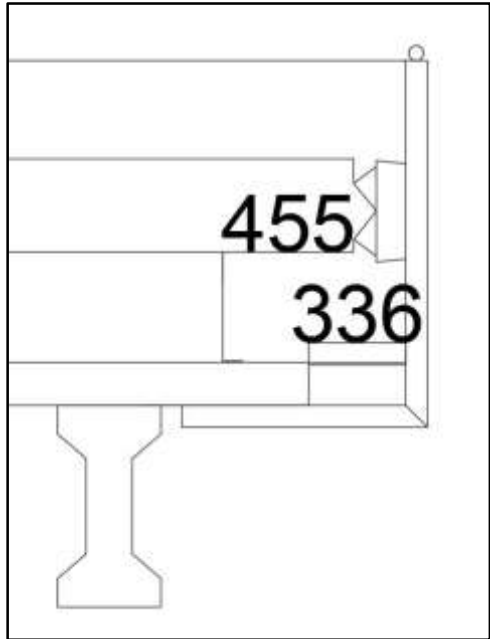
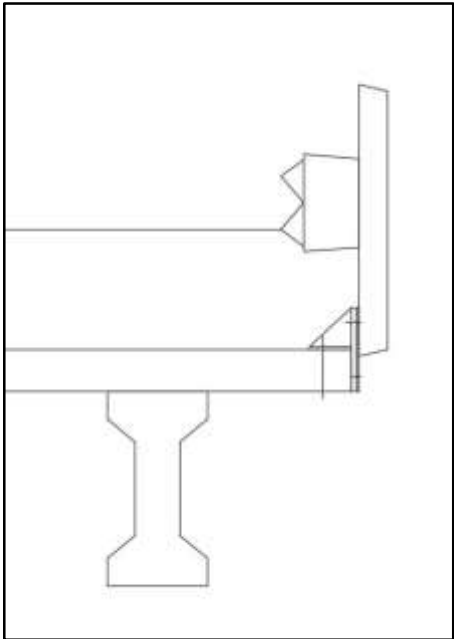
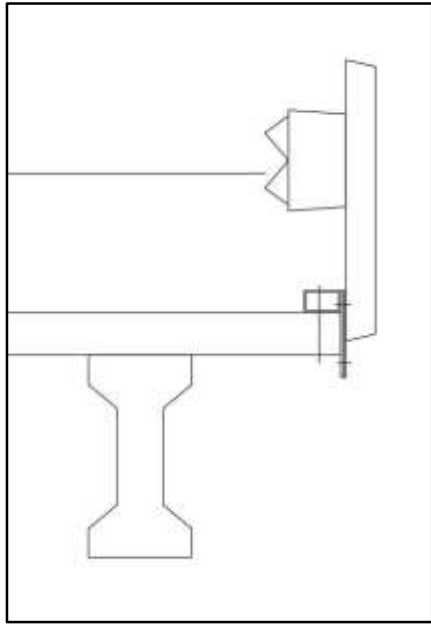
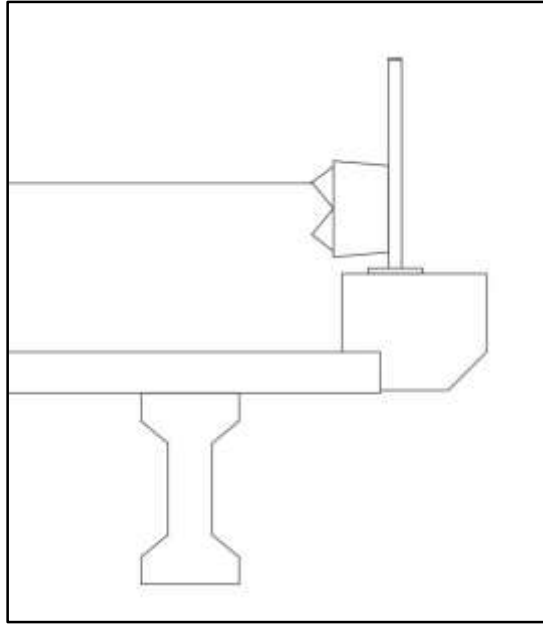
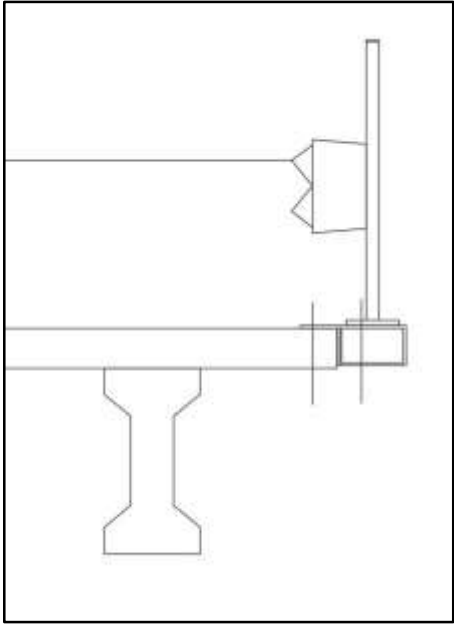

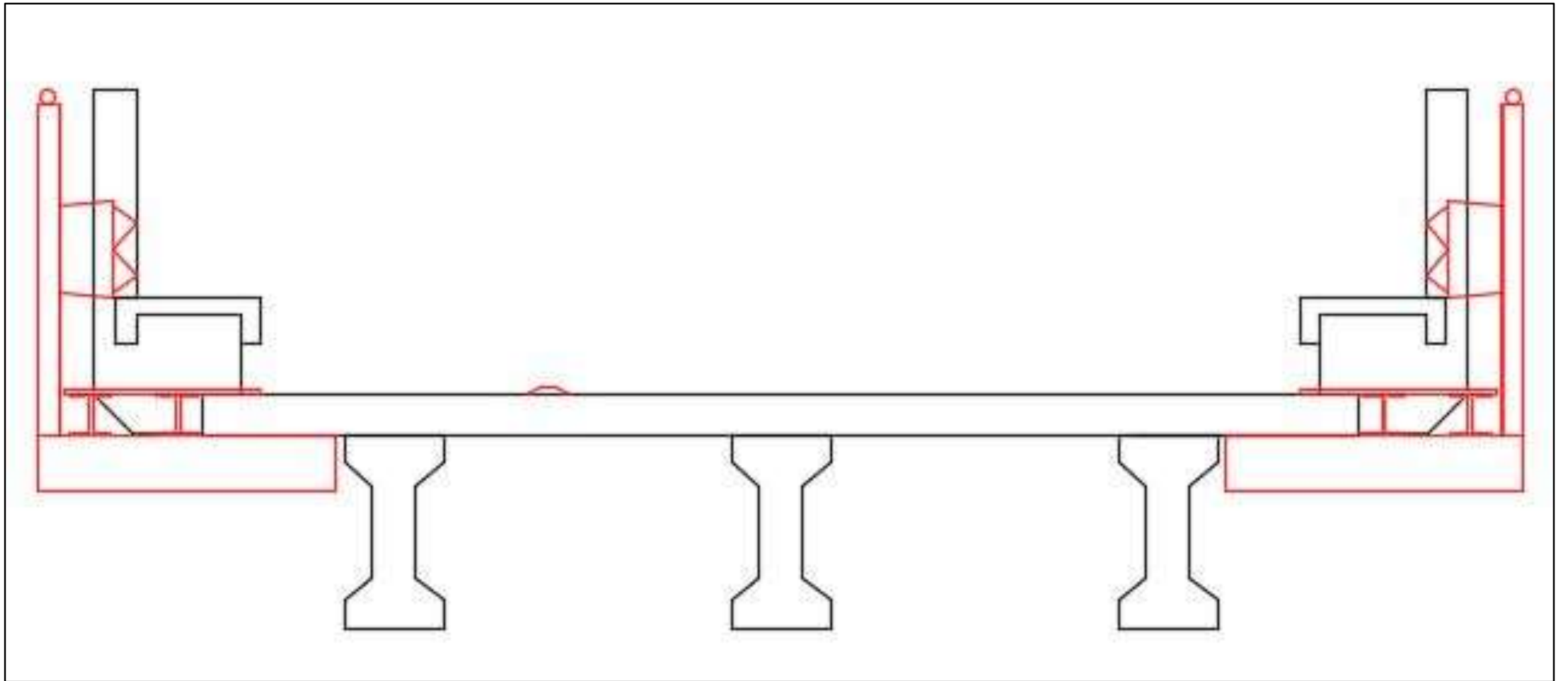

Optimum solution

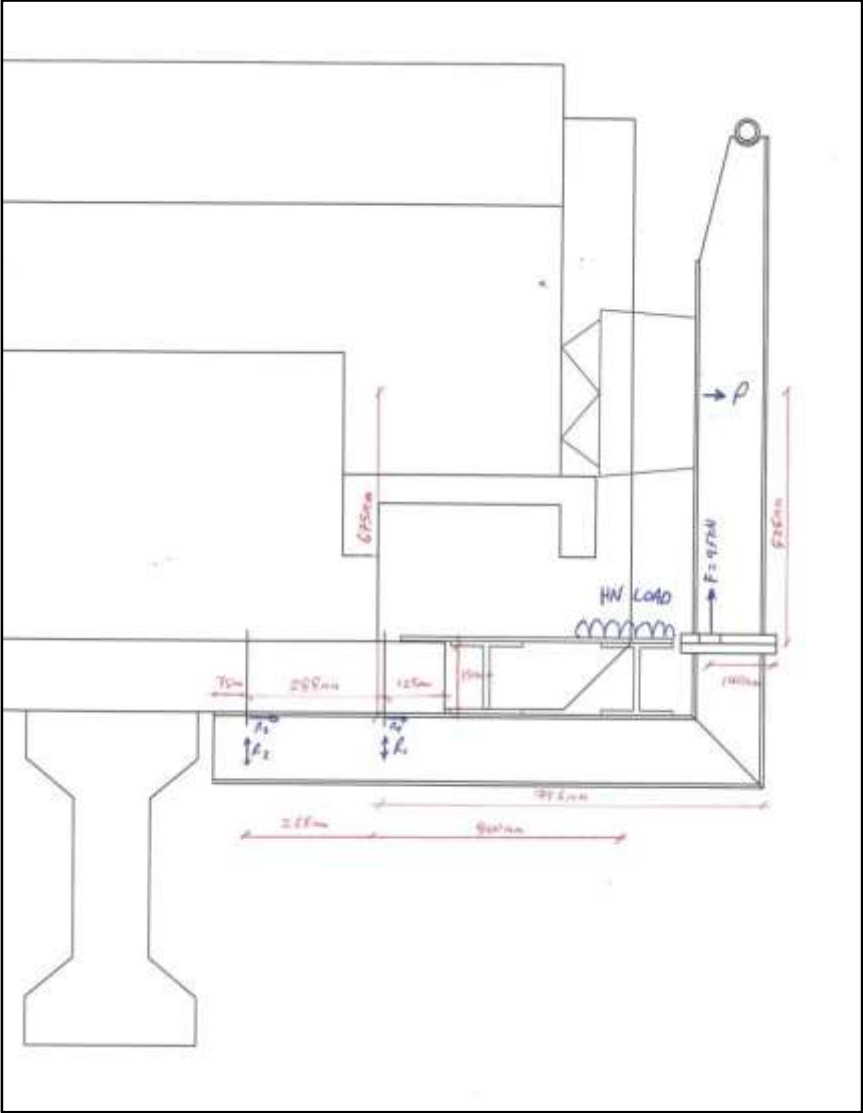

Loading diagram

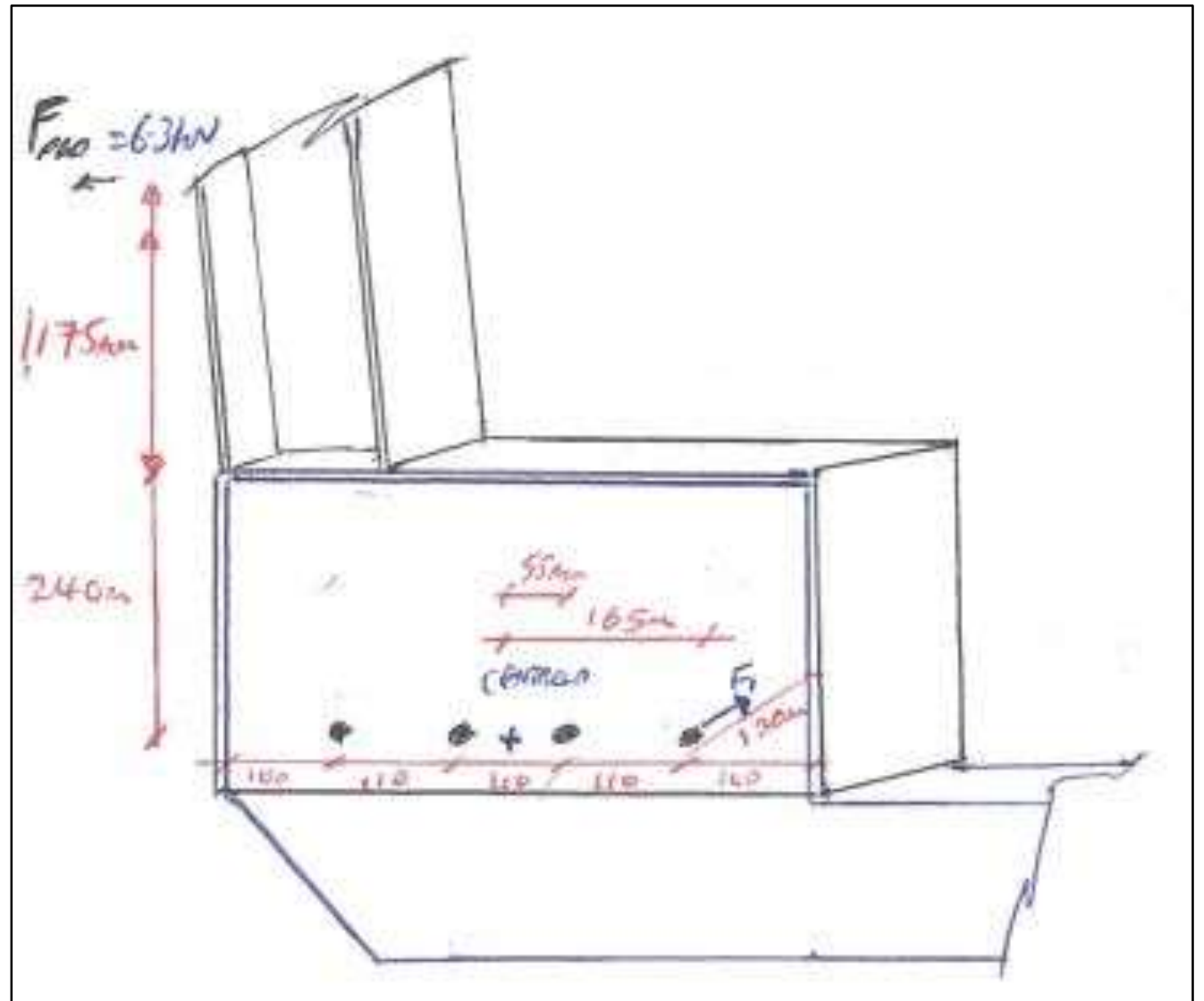
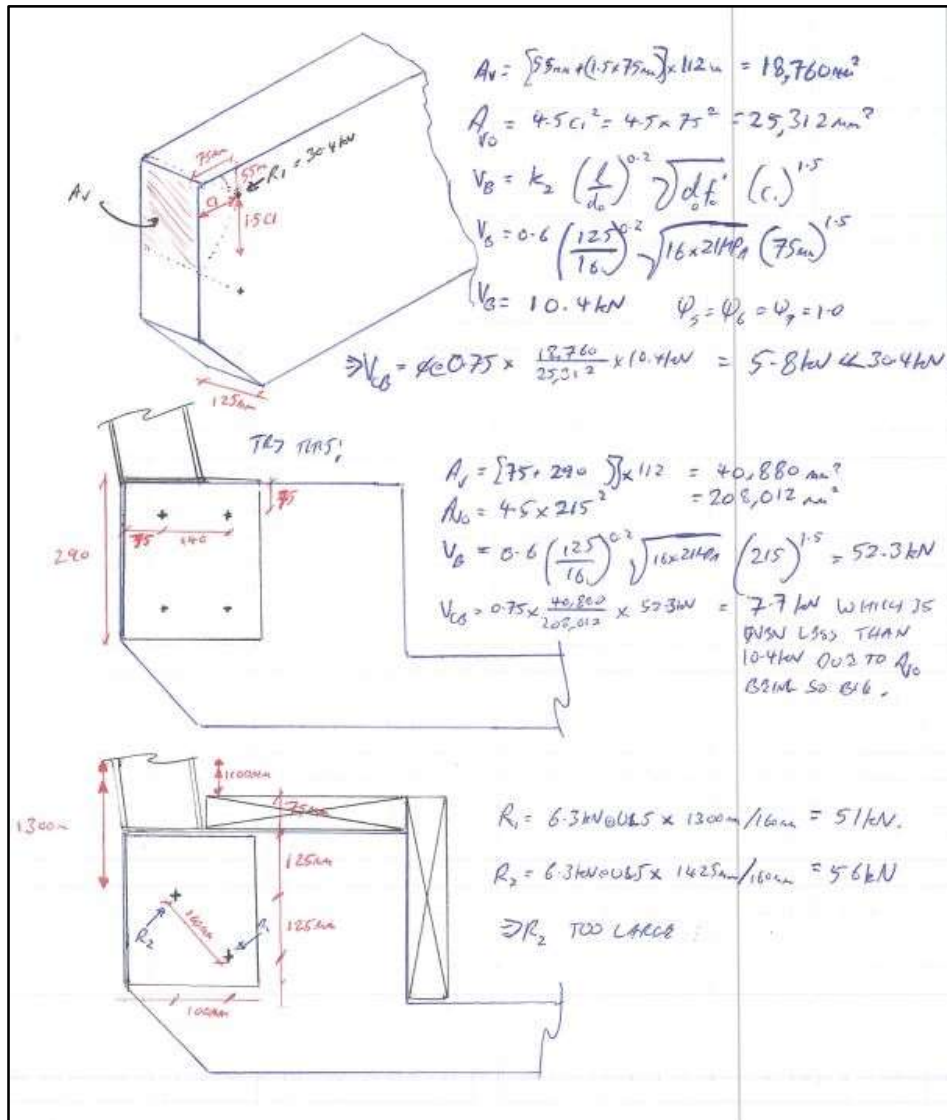

The 'pedestrian loads only' solution